

Kabebari batten detail

Profile: Square 50x50

Base: 0.547kg/m

Cover: 0.853kg/m

Total: 1.400kg/m

Batten thickness: 1.5mm

End cap thickness: 2.0mm

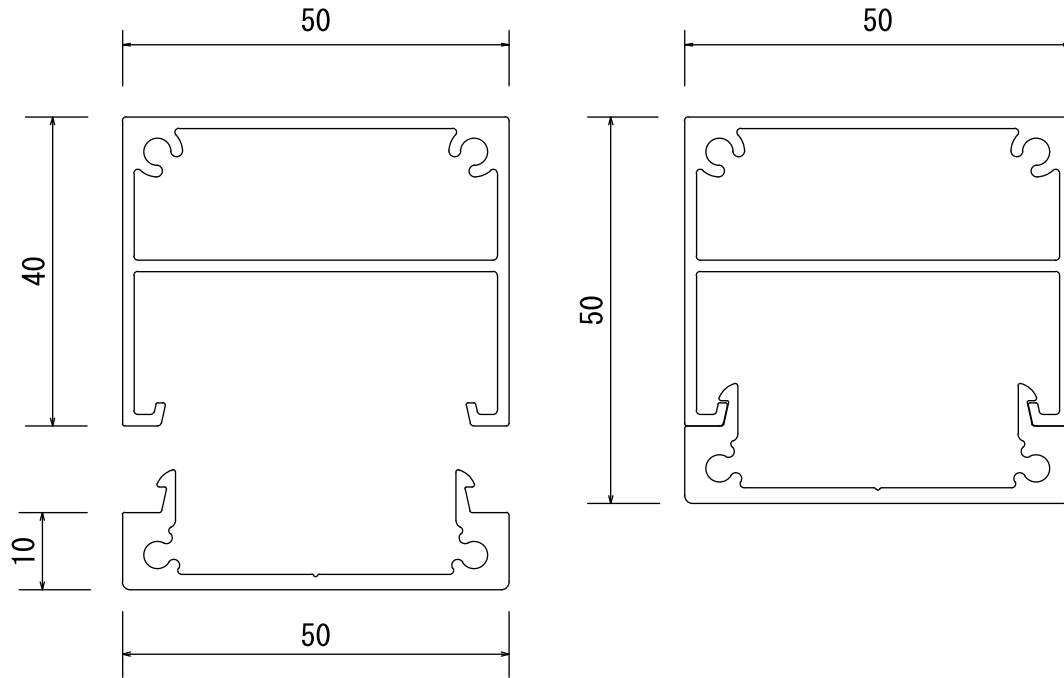

Endcap detail

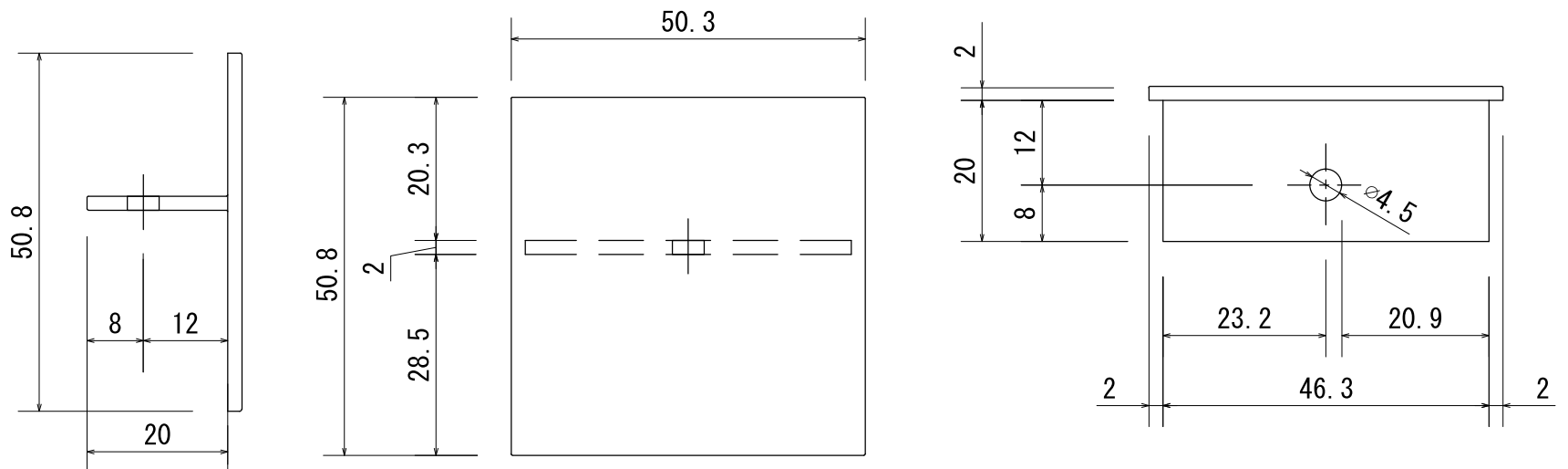

3			Product Name				Project Name	Creation Date	Page	Scale	Projection
2	Install	Never strike extrusion directly with a hammer or rubber mallet. Use a pine plank between the tool and the extrusion to avoid surface damage or denting.	Ever Art Wood - Kabebari				Square 50x50		1 of 2	1:1	⊕
1	End caps	Secure to batten with screw or exterior grade adhesive (Sikaflex), OR Screw fix or apply exterior grade adhesive (Sikaflex) to secure cap to batten.	Approval	Chek	Drawing	Design	Customer	Distributor		Manufacturer	
No.	DATE							covet			

Kabebari batten detail



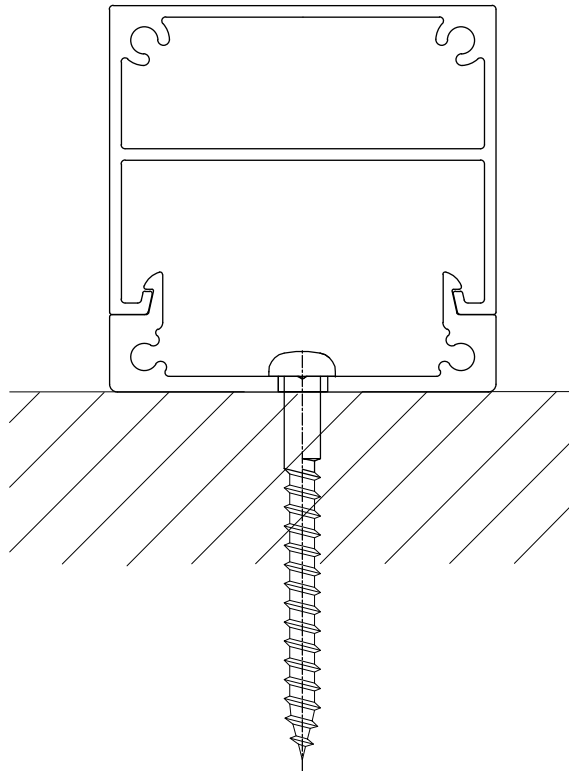

Profile: Square 50x50

Installation detail



Kabebari Batten Installation Guide

- Aluminium can be damaged if mishandled. Never strike directly with a hammer or rubber mallet. Use a pine plank between the striking rubber mallet and the extrusion to avoid surface damage or denting.
- Cut aluminium with a drop saw using an aluminium blade.
- Always cap ends of extrusions with supplied end caps or a flashing to avoid moisture ingress.
- Plastic end caps must be securely inserted with screws supplied or sikaflex applied to the inside of the extrusion before inserting. This will prevent slippage of the extrusion.
- Metal end caps (painted) must be screwed to the extrusion.
- All end caps can only be applied to straight 90 degree cuts. They cannot be applied to angle end cuts.
- Ensure appropriate screws are used to suit the substrate you are fastening to. It is important to use stainless steel or bi-metal screws for all metal surfaces impacted when fastening (i.e. furring channels, top hats, steel frames). This will prevent galvanic reaction between the screw/substrate and aluminium extrusion.
- Fasten at maximum 1 metre spans. Please contact Covet for further information.
- Always fasten the male (base) section first. The female (top section) clips over the top. They can also slide on if necessary.

			Product Name				Project Name	Creation Date	Page	Scale	Projection
	Install	Never strike extrusion directly with a hammer or rubber mallet. Use a pine plank between the tool and the extrusion to avoid surface damage or denting.	Ever Art Wood - Kabebari				Square 50x50		2 of 2	1:1	
	End caps	Secure to batten with screw or exterior grade adhesive (Sikaflex), OR Screw fix or apply exterior grade adhesive (Sikaflex) to secure cap to batten.	Approval	Chek	Drawing	Design	Customer	Distributor		Manufacturer	
No.	DATE							covet		