

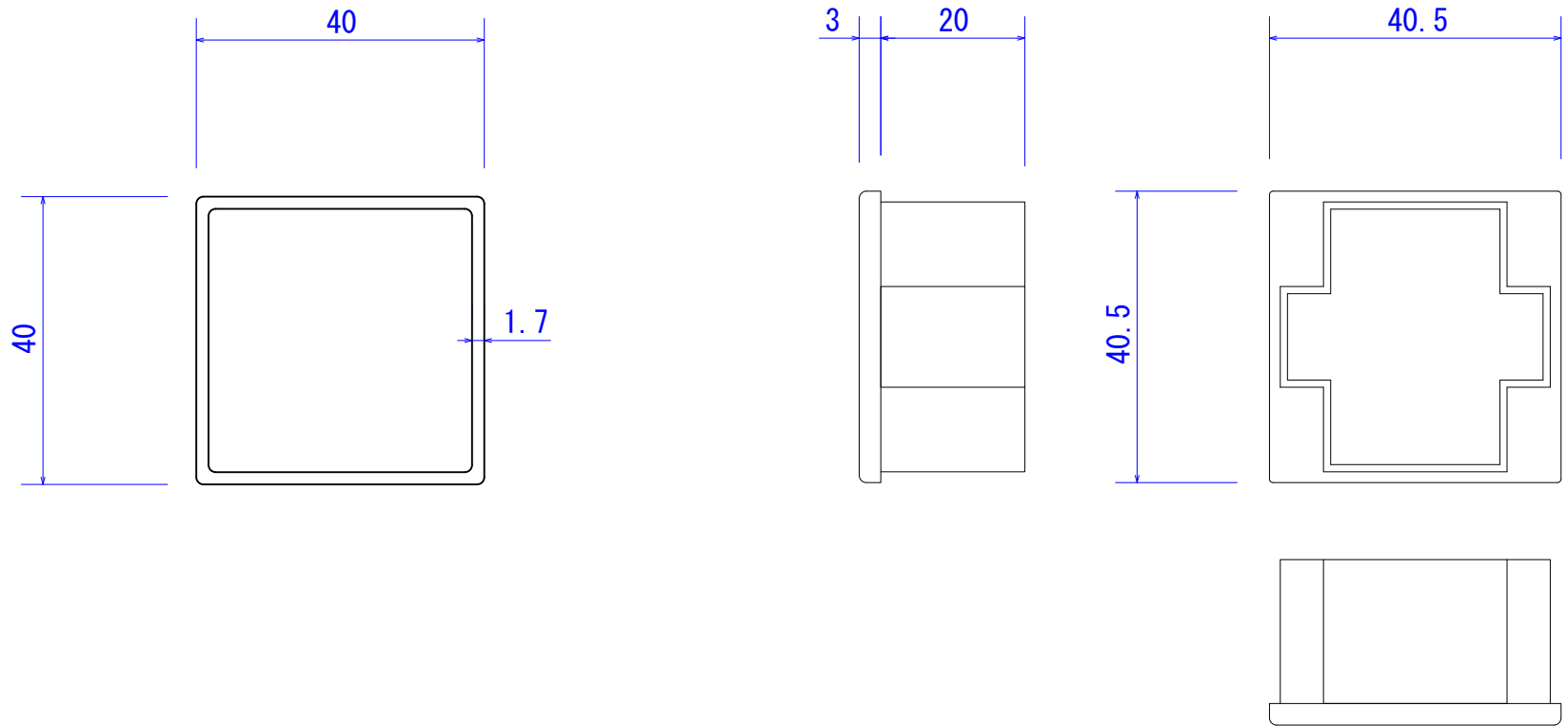





Koshi batten detail

Profile: Square 40x40

Weight: 0.703kg/m
 Batten thickness: 1.7mm
 End cap thickness: 3.0mm
 End cap: Coloured ABS plastic





Endcap detail



			Product Name				Project Name	Date	Page	Scale	Projection	
			KOSHI SQUARE 40X40					07/2021	1 of 2	1:1		
			Approval	Check	Drawing	Design			Covet International 27 / 131 Hyde St Yarraville VIC 3013		T +613 9398 8128 info@covet.com.au www.covet.com.au	
	Install	Never strike extrusion directly with a hammer or rubber mallet. Use a pine plank between the tool and the extrusion to avoid surface damage or denting.										
	End Caps	Screw fix or apply exterior grade adhesive (Sikaflex) to secure cap to batten.										

Koshi Batten Installation Guide

- Aluminium can be damaged if mishandled. Never strike directly with a hammer or rubber mallet. Use a pine plank between the striking rubber mallet and the extrusion to avoid surface damage or denting.
- Cut aluminium with a drop saw using an aluminium blade.
- Always cap ends of extrusions with supplied end caps or a flashing to avoid moisture ingress.
- Metal end caps (painted) must be screwed to the extrusion.
- All end caps can only be applied to straight 90 degree cuts. They cannot be applied to angle end cuts.
- Ensure appropriate screws are used to suit the substrate you are fastening to. It is important to use stainless steel or bi-metal screws for all metal surfaces impacted when fastening (i.e. furring channels, top hats, steel frames). This will prevent galvanic reaction between the screw/substrate and aluminium extrusion.
- Fasten at maximum 1 metre spans. Please contact Covet for further information.

		Product Name				Project Name	Date	Page	Scale	Projection
		KOSHI BATTENS					07/2021	2 of 2		
										
	Install	Never strike extrusion directly with a hammer or rubber mallet. Use a pine plank between the tool and the extrusion to avoid surface damage or denting.	Approval	Check	Drawing	Design	 Covet International 27 / 131 Hyde St Yarraville VIC 3013			
	End Caps	Screw fix or apply exterior grade adhesive (Sikaflex) to secure cap to batten.								