

# Koshi batten detail

## Profile: Rectangle 40X20

Weight: 0.605kg/m





Batten thickness: 2.0mm

End cap thickness: 3.0mm

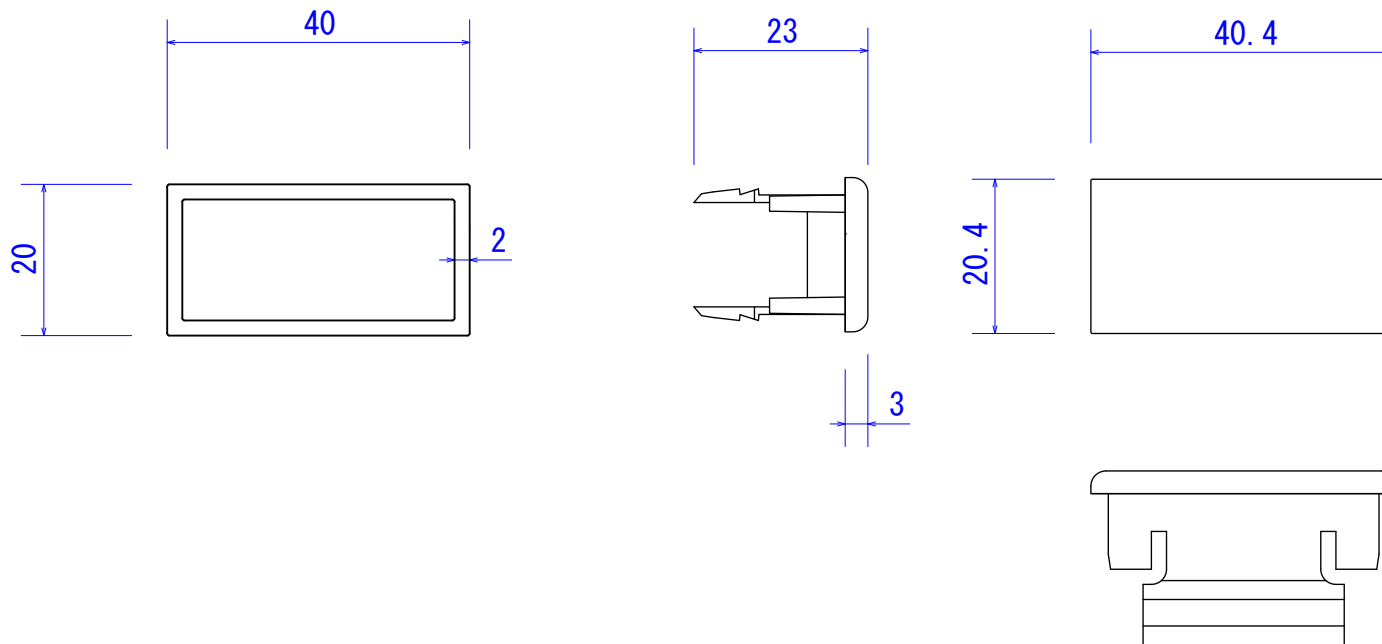
End cap: Coloured ABS plastic





### Endcap detail



		Product Name				Project Name		Date	Page	Scale	Projection	
		KOSHI RECTANGLE 40X20						07/2021	5 of 10	1:1		
												
	Install	Never strike extrusion directly with a hammer or rubber mallet. Use a pine plank between the tool and the extrusion to avoid surface damage or denting.				Approval	Check	Drawing	Design	 Melbourne Showroom 2 Ginibi Drive Altona North VIC 3025 T +613 9398 8128 info@covet.com.au www.covet.com.au		
	End Caps	Screw fix or apply exterior grade adhesive (Sikaflex) to secure cap to batten.										

## Koshi Batten Installation Guide

- Aluminium can be damaged if mishandled. Never strike directly with a hammer or rubber mallet. Use a pine plank between the striking rubber mallet and the extrusion to avoid surface damage or denting.
- Cut aluminium with a drop saw using an aluminium blade.
- Always cap ends of extrusions with supplied end caps or a flashing to avoid moisture ingress.
- Metal end caps (painted) must be screwed to the extrusion.
- All end caps can only be applied to straight 90 degree cuts. They cannot be applied to angle end cuts.
- Ensure appropriate screws are used to suit the substrate you are fastening to. It is important to use stainless steel or bi-metal screws for all metal surfaces impacted when fastening (i.e. furring channels, top hats, steel frames). This will prevent galvanic reaction between the screw/substrate and aluminium extrusion.
- Fasten at maximum 1 metre spans. Please contact Covet for further information.

		Product Name				Project Name		Date	Page	Scale	Projection
		KOSHI BATTENS						07/2021	10 of 10		
											
	Install	Never strike extrusion directly with a hammer or rubber mallet. Use a pine plank between the tool and the extrusion to avoid surface damage or denting.	Approval	Check	Drawing	Design	<b>covet</b> <sup>®</sup>		Melbourne Showroom 2 Ginibi Drive Altona North VIC 3025		T +613 9398 8128 info@covet.com.au www.covet.com.au
	End Caps	Screw fix or apply exterior grade adhesive (Sikaflex) to secure cap to batten.									